

# O.N.100 Odour Neutraliser



## Technical and Operations Manual

For Models: O.N.100



## Using this manual

This manual is intended to be used as a work of reference for professional, properly trained and authorised users to assist them in safely installing, using, maintaining and repairing the Unit mentioned on the cover of this document.

Please note that it is strongly recommended that training is given by Purified Air Limited prior to operatives attempting to carry out maintenance or repair work on this Unit.

---

## Copyright Statement

### **All rights reserved**

No part of this publication may be copied or published by means of printing, photocopying, microfilm or otherwise without prior written consent of the manufacturer. This restriction also applies to the corresponding drawings and diagrams.

The information given in this manual has been collected for the general convenience of our clients. It has been based on general data pertaining to construction material properties and working methods known to us at the time of issue of the document and is therefore subject, at any time, to change or amendment and the right to change or amend is hereby expressly reserved. The instructions in this publication only serve as a guideline for installation, use, maintenance and repair of the model mentioned on the cover page of this document.

This manual is to be used for the standard model of the Unit of the type given on the cover page. Thus the manufacturer cannot be held responsible for any damage resulting from the application of this manual to the version actually delivered to you.

This manual has been written with great care. However, the manufacturer cannot be held responsible, either for any errors occurring in this manual or their consequences.

## Contents

<b>1. Safety</b>	<b>1</b>		
1.1 Introduction	1		
1.2 Safety Warnings and Instructions	2		
1.3 Pictograms, Warnings and Instructions Displayed on the Unit	3		
1.4 Safety Features	4		
1.5 Safety Warnings and Cautions	4		
1.6 Modifications	5		
1.7 Users	5		
1.8 Technical Specifications	6		
1.8.1 Rating Plate	6		
<b>2. Product Overview</b>	<b>7</b>		
2.1 Intended Use	7		
2.2 Features	7		
2.3 Operating Principles	8		
2.4 O.N.100 Odour Neutraliser - Components	9		
<b>3. Storage, Unpacking and Handling</b>	<b>10</b>		
3.1 Storage	10		
3.2 Shipping List	10		
3.3 Unpacking and Handling	10		
<b>4. Installation Guidance</b>	<b>11</b>		
4.1 Overview	11		
4.2 Model Dimensions	12		
4.3 Assembling the O.N.100 Main Unit	12		
4.4 Installing the O.N.100	13		
4.4.1 Installing the Main Unit	14		
4.4.2 Installing the Spigot	16		
<b>5. Operation and Control</b>	<b>18</b>		
5.1 Commissioning	18		
<b>6. Maintenance and Cleaning</b>	<b>19</b>		
6.1 Maintenance	19		
6.1.1 Addition of Neutralising (ELIMINODOR <sup>®</sup> ) Fluid.	19		
6.2 Cleaning	20		
6.2.1 After Topping up with ELIMINODOR <sup>®</sup> .	20		
<b>7. Troubleshooting</b>	<b>21</b>		
7.2.1 Troubleshooting Checklist	21		
<b>8. Spare Parts List</b>	<b>22</b>		
		8.1 Spare Parts Ordering	22
		<b>9. Unit Wiring Diagram</b>	<b>23</b>
		10.1 Equipment Disposal	24
		10.2 Packaging Material Disposal	24
		10.3 Used Unit Disposal	24
		<b>11. Contact Details</b>	<b>25</b>
		11.1 Nationwide Coverage	25
		11.2 Service and Maintenance Contracts	25
		11.3 Dependability	25
		11.4 Global Sales	25
		<b>12. Warranty Statement</b>	<b>26</b>
		<b>13. Certification</b>	<b>27</b>
		13.1 EC Declaration of Conformity	27
		<b>14. Safety Datasheets</b>	<b>28</b>
		14.1 ELIMINODOR <sup>®</sup> Health and Safety Datasheet	28
		14.2 COSHH Assessment for ELIMINODOR <sup>®</sup>	31



## 1. Safety

### 1.1 Introduction

Everyone working on or with the Unit must be familiar with the contents of this manual and must strictly observe the instructions herein.

The Management should instruct personnel in accordance with this manual and observe all instructions and directions given herein.

**Note:** Always follow the steps for any instructions in this manual in the order given.

Always keep this manual with the Unit.

The user of the Unit is always fully responsible for observing all applicable local safety instructions and regulations.

Specific working conditions or selected accessories may require additional safety instructions. Contact your supplier immediately if you detect a potential danger when using the Unit.

## 1.2 Safety Warnings and Instructions

The following symbols and notifications are used in this manual:



**WARNING!**

Used to indicate where there is a risk of injury or death.



**WARNING! - DANGER OF ELECTRIC SHOCK!**

Used to indicate where there is a risk of injury or death from electric shock.



**CAUTION**

Used to indicate where there is a risk of damage to equipment.



**INFORMATION**

Important information or useful hints about usage.



**RECYCLING**

Recycling information.



**WEEE REGULATIONS**

Used to ensure that waste electrical equipment is disposed of correctly.



**ENVIRONMENTAL HAZARD**

Used to indicate where a biological substance threatens the health of living organisms especially humans.



**HARMFUL IRRITANT**

Used to indicate a substance causing temporary or reversible inflammation of living tissue.



### 1.3 Pictograms, Warnings and Instructions Displayed on the Unit

The pictograms, warning and instructions attached to the Unit are part of the safety features.

They must not be covered or removed and must be present and legible during the entire life of the Unit.

- Immediately replace or repair damaged or illegible pictograms, warnings and instructions.



Figure 1 - Unit Label



Figure 2 - O.N.100 Labels

## 1.4 Safety Features



### CAUTION

- All safety features must be correctly fitted and can only be removed for maintenance and repair jobs by skilled and authorised service engineers.
- The Unit must not be used if the safety features are not fully present or defective.
- The safety features should be regularly checked for their proper functioning and, if defective, should be immediately repaired.

## 1.5 Safety Warnings and Cautions

To guard against injury, basic safety precautions should be observed, including the following before attempting to use the Unit:



### WARNING! RISK OF EXPLOSION!

The Unit is not explosion-proof rated. It can cause sparks and should therefore not be used in areas with an explosion risk.



### WARNING!

- Fire Hazard! Never use the Unit for extracting and/or filtering inflammable, glowing or burning particles or solids or liquids.
- Never use the Unit for extracting and/or filtering aggressive fumes (such as hydrochloric acid) or sharp particles.



### WARNING! - DANGER OF ELECTRIC SHOCK!

To avoid electric shock:

- Do not operate Unit without a proper electrical ground/earth.
- Always disconnect power to the Unit and isolate the Unit, before performing any service or maintenance.
- Do not operate the Unit if the power cables are damaged, or if any other damage to the Unit is visible or suspected.
- The supplied utility/mains power must match the power requirements listed on the Unit's rating label.



### ENVIRONMENTAL HAZARD

On spillage a substance which has the potential to threaten the surrounding natural environment.



**HARMFUL IRRITANT**

Corrosive substances cause temporary inflammation of living tissue. Gloves and eye protection must be worn when using corrosive substances.



**CAUTION**

- Make sure the room is always sufficiently ventilated, particularly in smaller confined areas.
- Do not use the Unit at a relative humidity exceeding 75%.
- Do not use the Unit at temperatures below 5°C or above 56°C.
- Check the working environment. Do not allow unauthorised persons to enter the working environment.
- Use common sense. Stay alert and pay attention to your work. Do not use the Unit when you are tired or under the influence of drugs, alcohol or medicine.
- Regularly inspect the Unit and check it for damage.
- Verify the correct functioning of all of the safety features.
- Read and save all notices, warnings and safety instructions received with this Unit.
- Do not alter the construction or design of this Unit.
- Do not remove safety labels or devices.
- Do not use this equipment for other than its intended purpose, as described in this manual.
- Only use original spare parts.
- Keep the operating controls free from dirt and grease.

## 1.6 Modifications

Modification of the Unit is not permitted.

## 1.7 Users

Installation or maintenance of the Unit is exclusively reserved for authorised, trained and qualified users.

Temporary personnel and trainees should only access the Unit under the supervision and responsibility of authorised, trained and qualified users.

## 1.8 Technical Specifications

The technical specifications of the O.N.100 are listed below:

<b>Electrical Supply</b>	220/240V 50Hz
<b>Max Power Consumption</b>	50 Watts
<b>Ionisation Voltage</b>	12kV negative
<b>Max Air Volume</b>	up to 4.16m <sup>3</sup> /sec
<b>Weight:</b>	12.25kg

### 1.8.1 Rating Plate



Figure 3 - O.N.100 Rating Plate

## 2. Product Overview

### 2.1 Intended Use

The O.N.100 is designed to be installed in the extraction ducting of a commercial kitchen, downstream of the extraction hood and upstream of the extraction fan, to remove odours from pre-filtered kitchen extraction system fumes from which particulates have previously been removed.



#### CAUTION

The airstream must first be cleaned of the majority of particulate contaminants made up of hydrocarbons and grease vapour, leaving only the gaseous phase (odour) to be treated by the O.N.100.



#### INFORMATION

To efficiently filter the gaseous phase of particulates, we also supply a full range of electrostatic and passive filtration equipment, including Activated Carbon, Baffle, Mesh, HEPA, Bag and Panel filters.



#### CAUTION

Using the Unit for other purposes is considered contrary to its intended use. The manufacturer accepts no liability for any damage or injury resulting from such use.

### 2.2 Features

When installed correctly, Purified Air's O.N.100 has the following features and associated benefits:

- Instant control of odours via the ELIMINODOR<sup>®</sup> concept, with up to 90% of odours eliminated.  
Dependent on the level of activity within the kitchen, only a faint odour of cooking or ELIMINODOR<sup>®</sup> (the neutralising chemical) will be detected directly at the discharge.
- A visual indication of the neutralising chemical's (ELIMINODOR<sup>®</sup>) level.
- Fully adjustable.
- Simple and economical to maintain.
- Easily installed into new/existing systems.
- No resistance to airflow in the extraction duct.  
The O.N.100 does not cause any pressure drop and can therefore be installed into any new or existing system without needing to upgrade the fan.
- User-friendly controls.

The O.N.100 works by adding an odour neutralising chemical (ELIMINODOR®) to the airstream extracted from the kitchen.

The ELIMINODOR® neutralising chemical produced by Purified Air Limited combines odour neutralising agents with materials that impart a pleasant scent to the air.

The O.N.100 unit is supplied with an Eliminator fluid level, float indicator, built into the tank. This provides a volt free contact to indicate when the Eliminator has reached a low level and requires topping up that can be connected to a BMS system if required.

### 2.3 Operating Principles

After being cleaned of the majority of particulate contaminants by suitable Purified Air Units, the gaseous phase of the contamination passes the O.N.100 Unit for odour elimination by the Odorfoyl process as follows:

1. Ambient air is drawn into the Unit and mixed with the odour neutralising chemical (ELIMINODOR®).
2. A vapour is formed which is then ionised to a negative potential of 15,000V by a High Voltage Power Supply.
3. The flow of neutralising chemical (ELIMINODOR®) is controlled by the air velocity within the duct therefore, once a system is commissioned and balanced, the optimum dosage will always be supplied.
4. The metal ducting is earthed through the High Voltage Power Supply's circuit giving the contaminants an opposite potential to the negatively charged vapour.
5. The electrostatic difference between the contaminants and the neutralising vapour causes the two to combine, facilitating chemical reactions between them which neutralise the malodour.

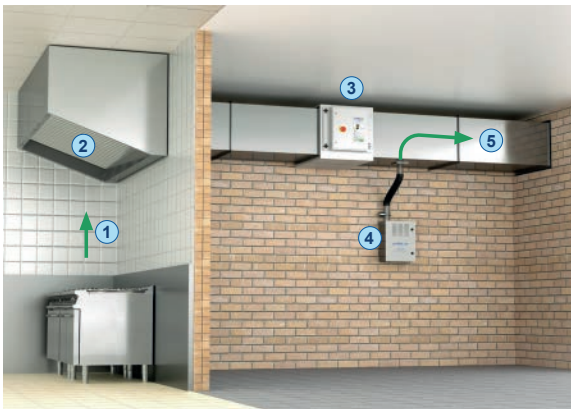

- 1 Cooking particulates and odours
- 2 Canopy Grease Filter
- 3 ESP - Particulate Control Unit
- 4 ON100 Odour Control Unit
- 5 ELIMINODOR® joins airflow

Figure 4 - O.N.100 Operating Principles

## 2.4 O.N.100 Odour Neutraliser - Components

The O.N.100 Odour Neutraliser comprises:

- A main Unit with a lockable front panel, containing:
  - ▶ A high voltage power supply.
  - ▶ A tank with filling spout and level indicator.
  - ▶ A fan with an adjustable speed controller.
- A Non Conductive Venturi spigot with associated Spigot and Damper Control Assembly.



**Figure 5 - Typical Front Panel and Control Damper Knob**

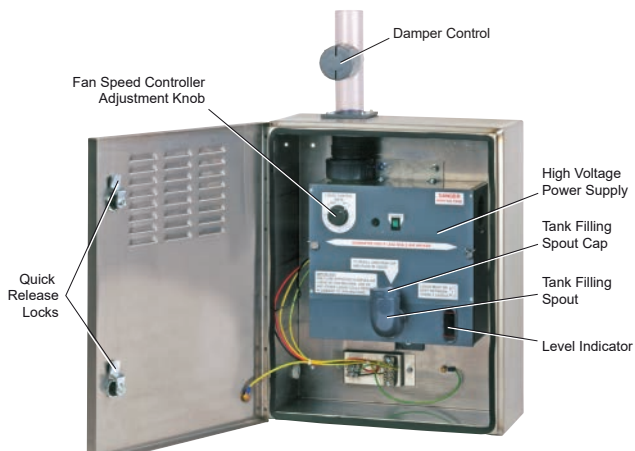

**Figure 6 - O.N.100 Components and Controls**

### 3. Storage, Unpacking and Handling

#### 3.1 Storage

Prior to installation, each O.N.100 Unit, must be stored in its original packaging in dry conditions.

#### 3.2 Shipping List

Each Unit is shipped with the following:

- O.N.100 Main Unit
- Venturi Tube
- Spigot
- Damper Control Assembly
- x 3 Jubilee Clips
- Can of ELIMINODOR® Neutralising Solution

#### 3.3 Unpacking and Handling

The O.N.100 Unit must only be unpacked by trained, professional installers.

Before installing:

Strip away all packaging, wrapping and strapping (this must only be done by trained, professional installers) and remove the Unit and associated components.



#### CAUTION

See Technical Specifications for the Unit's weight.



Figure 7 - O.N.100 Associated Components



## 4. Installation Guidance

### 4.1 Overview

The Unit can be freestanding on a flat surface or fixed to a wall or duct.

- Wherever the Unit is positioned you should bear in mind that frequent access will be required to replenish the neutralising fluid.



#### CAUTION

- **Never install the Unit in front of entrances and exits which may be used by emergency services.**
- **The O.N.100, wherever possible, should be interfaced with the extract fan.**
- **Installation of the O.N.100 Unit must only be made on the negative pressure side of the fan.**
- **If there is ductwork inside the premises on the positive pressure side of the fan, please ensure that it is completely sealed so as not to let fumes or odour control compounds back into the premises.**
- **Make sure that the Unit is mounted level and upright.**
- **If the O.N.100 Unit is fixed to a wall or duct, ensure that the suspension construction is adequate prior to installing the Unit.**

## 4.2 Model Dimensions

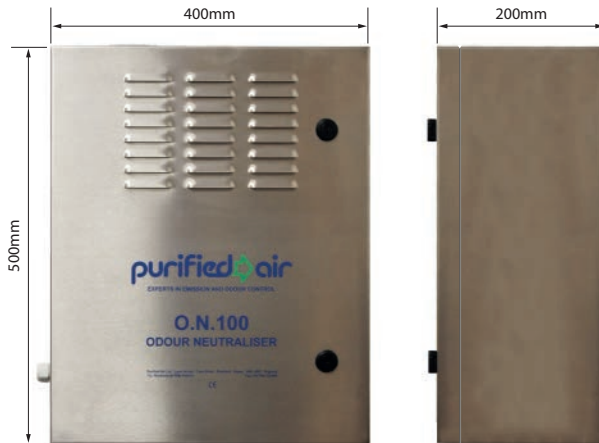
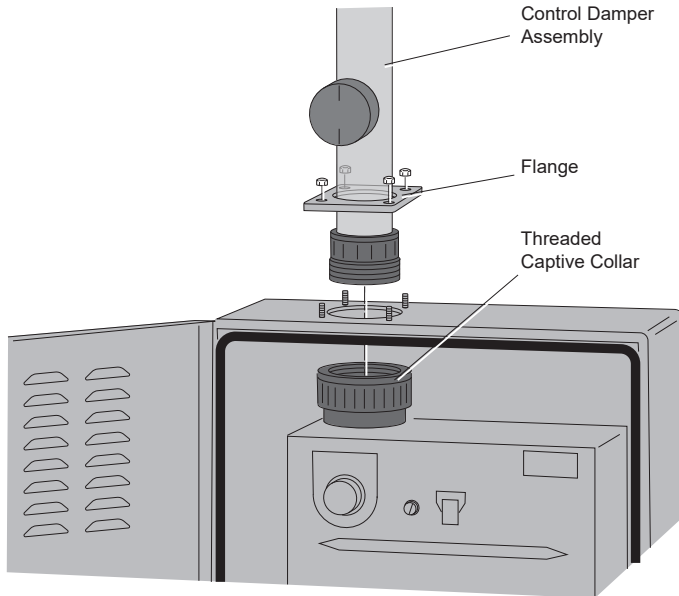

Figure 8 - O.N.100 Unit Dimensions

## 4.3 Assembling the O.N.100 Main Unit

Prepare the O.N.100's main unit for installation by attaching the Control Damper Assembly as follows:

1. Pass the threaded end of the Control Damper Assembly through the hole in the top of the Unit's casing.
2. Screw the Threaded Captive Collar onto the threaded end of the Control Damper Assembly
3. Secure the Control Damper Assembly into place by positioning the Flange over the four captive threaded studs and tightening the four hexagonal nuts.



*Figure 9 - Assembling the O.N.100 Main Unit*

#### 4.4 Installing the O.N.100

To install and setup the O.N.100, first install the main Unit and then connect the Venturi Tube and Spigot to the extraction ducting.

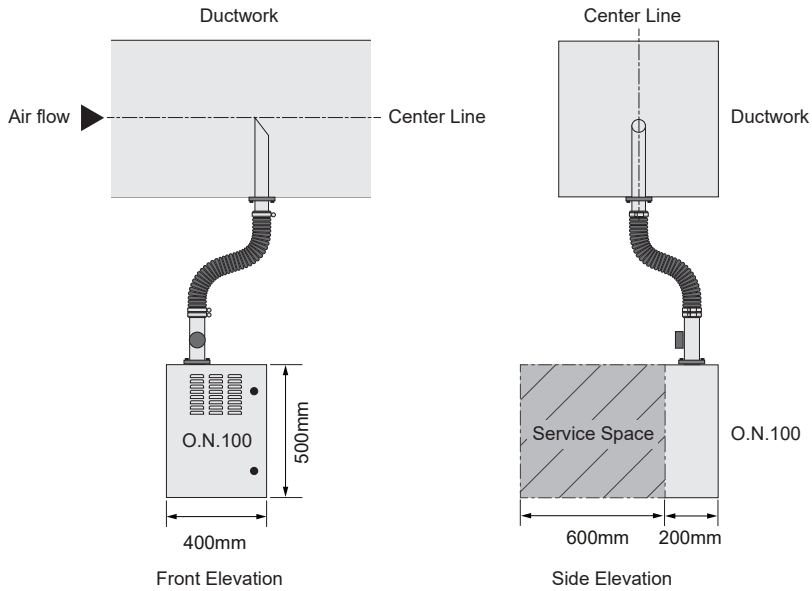

Figure 10 - O.N.100 Installation Schematic

#### 4.4.1 Installing the Main Unit

1. Place the Unit where it is to be located, allowing at least 600mm in front of the Unit to allow for access for servicing.

**Note:** If access equipment is required for servicing the Unit, more space may be required in front of the Unit.



#### CAUTION

- Please consult the Unit Wiring diagram (see 9. Unit Wiring Diagram on page 23) when connecting the O.N.100 to the mains. Beware of possible differences in the mains power supply.
- The Unit should be connected so that it only runs when the extractor fan is running.
- The Unit will not function properly if the ducting is not earthed as this conveys the electrostatic difference between the pollutant and the neutralizing fluid. Therefore, it is important to connect an earth lead to the ducting the Unit will be serving (if the ducting is painted, scrape the paint away under the earth lead's connection to the ducting to ensure electrical continuity).

2. Connect to a single-phase electrical supply.
3. Once the Unit is in position, the Control Damper assembly has been attached and

the Unit connected to the mains electrical supply, test the operation of the Unit, prior to completion of the installation, as follows:

- i. Unlock and open the front cover of the Unit and locate the Liquid Control Rate Knob which controls the speed of the Unit's fan (see *Figure 12 - Liquid Control Rate Knob and Filler Cap on page 15*).



**INFORMATION**

The fan is used to evaporate and mix the neutralising fluid with air in the Unit's mixing chamber.

The fan's speed determines the rate of evaporation of the neutralising fluid.

- ii. Turn the Liquid Control Rate to 'MAX' and fully open the Control Damper by turning its knob clockwise.

You should now be able to detect the air coming out of the Control Damper Assembly's outlet.

- iii. Check that turning the Liquid Control Rate Knob anti-clockwise and clockwise alters the air volume, and therefore the rate of neutralising fluid delivery, as required.



*Figure 11 - Liquid Control Rate Knob and Filler Cap*

4. Now that operation of the Unit itself has been checked:
  - i. To switch off the fan, turn the Liquid Control Rate to 'OFF'.
  - ii. Unscrew the tank's filler cap (see *Figure 12 - Liquid Control Rate Knob and Filler Cap on page 15*).
  - iii. Pour the contents of the supplied bottle of ELIMINODOR<sup>®</sup> into the tank and replace the filler cap.

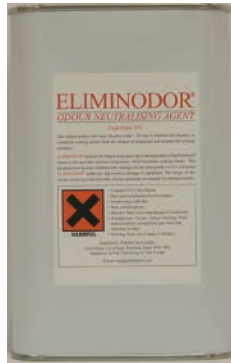

Figure 12 - ELIMINODOR® Odour Neutralising Agent



Figure 13 - Tank Filler

- iv. To switch the fan on, turn the Liquid Control Rate to 'MAX', you should now be able to detect a strong odour of ELIMINODOR®.

#### 4.4.2 Installing the Spigot

Following completion of the first stage of the installation procedure, the Unit can now be switched off and the O.N.100's installation completed by the installation of the Spigot.



**CAUTION**

The Spigot must be installed at least one metre (m) prior to the duct's extraction fan and, if possible, in a straight piece of ducting away from bends and other obstructions that will disrupt the airflow.

Install the Spigot as follows:

1. Drill a 50mm hole in the ducting to accommodate the Spigot.  
**Note:** This is best carried out with a tank cutting drill bit.
2. The Spigot tip should be as close to the centre of the ducting as possible (see *Figure 11 - O.N.100 Installation Schematic on page 14*).  
**Note:** If necessary, the Spigot can be cut to the correct length if it is too long, though material should only be taken from the base of the Spigot, not its angled end.
3. The angled face of the Spigot **MUST** face away from the airflow in order to establish a venturi effect.



**CAUTION**

Under no circumstances should the angled face of the Spigot be positioned in any direction other than **AWAY** from the airflow as this can cause blow back and prevent the system from working at all.

5. Once the Spigot is in place it should be secured using self tapping screws through its flange and into holes drilled into the ducting.



**INFORMATION**

The flange is a tight push fit over the Spigot, when the Spigot's final position is settled, you may wish to fix the Spigot to the flange to prevent any movement. This can be carried out by using a good quality PVC glue.

6. Place the three jubilee clips over the Venturi Tube.
7. The Spigot can now be connected to the Unit via the Venturi Tube.  
Push one end of the Venturi Tube onto the top of the Control Damper Assembly protruding through the Unit's case and the other onto the Spigot installed in the ducting.
8. Once the hose is in place, place two of the jubilee clips over the bottom (Control Damper Assembly) connection and one over the Spigot connection and then tighten them.



**CAUTION**

Be sure not to overtighten the jubilee clips, as this may crack the Control Damper Assembly or Spigot.

## 5. Operation and Control

In normal use, the Unit is switched on by connecting to the mains power supply and turning the Liquid Control Rate Knob, located inside the front cover (see *Figure 12 - Liquid Control Rate Knob and Filler Cap on page 15*), to a previously determined setting (see *5.1 Commissioning on page 18*).

**Note:** Before using the Unit for the first time, a period of commissioning should be undertaken (see *5.1 Commissioning on page 18*).

### 5.1 Commissioning

Once the O.N.100 is fully installed, it should be adjusted to minimise the consumption of ELIMINODOR<sup>®</sup> (the odour neutralising fluid) and maximise the elimination of odours as follows:

1. Turn the fan to 'Level 3' and make sure Control Damper is fully closed in the horizontal position.
2. Gradually increase the output of the Unit by turning the Control Damper's knob (see *Figure 6 - Typical Front Panel and Control Damper Knob on page 9*) clockwise until the smell of both kitchen odour and ELIMINODOR<sup>®</sup> can only be faintly detected.

The Unit is now set correctly.



#### INFORMATION

Cooking odour may be detected at the discharge point but, if you stand back a metre or so from the end of the duct, you will note that the majority of the cooking odour has been neutralised.

Unless dealing with an extraordinarily odorous system, ELIMINODOR<sup>®</sup> is designed to evaporate into the system in very small quantities.

If, after twenty minutes operation, more than a trace of ELIMINODOR<sup>®</sup> can be seen in either the Spigot or the Control Damper's transparent tube, then the air velocity leaving the Unit is too high, leading to excessive ELIMINODOR<sup>®</sup> being evaporated.

To reduce the evaporation of ELIMINODOR<sup>®</sup>, turn the Control Damper Knob gradually anti-clockwise until the optimum setting is found.



#### INFORMATION

It may take some time to find this setting and it is recommended that this exercise be carried out over a period of a few hours to ensure that the settings are correct.



## 6. Maintenance and Cleaning

### 6.1 Maintenance



#### WARNING

Always disconnect mains power from the equipment before performing any service or maintenance.

Do not carry out any service, maintenance or repairs on the Unit before it has been protected against unintended starting.

The only maintenance required is daily checking of the ELIMINODOR<sup>®</sup> neutralising chemical's level and topping it up if necessary.

#### 6.1.1 Addition of Neutralising (ELIMINODOR<sup>®</sup>) Fluid.

The amount of ELIMINODOR<sup>®</sup> consumed will depend on the type of cooking odour present and the volume of air passing through the extraction duct.

**Note:** An average installation should use approximately one litre of ELIMINODOR<sup>®</sup> solution every three to four weeks.

To refill the Unit:

1. Unlock and open the Unit's front cover (see *Figure 6 - Typical Front Panel and Control Damper Knob on page 9*).
2. Turn the Unit off by turning the Liquid Control Rate Knob (see *Figure 12 - Liquid Control Rate Knob and Filler Cap on page 15*) to 'OFF'.
3. Remove the filler cap and pour in the ELIMINODOR<sup>®</sup> solution (see *Figure 14 - Tank Filler on page 16*).

**Note:** Ensure that the liquid's level is maintained between the upper and lower red lines on the reservoir's Level Indicator to ensure the Unit's optimum performance (see *Figure 12 - Liquid Control Rate Knob and Filler Cap on page 15*).



#### CAUTION

Overfilling the Unit may lead to damage. Once the Unit has been filled replace the filler cap and return the Liquid Control Rate Knob to its previous position.



#### CAUTION

Never allow the system to run dry for more than twenty four hours.

4. Replace the filler cap.
5. Turn the Unit back on by turning the Liquid Control Rate Knob clockwise.
6. Close and lock the Unit's front cover.



**CAUTION**

**ONLY USE PURIFIED AIR'S ELIMINODOR<sup>®</sup> SOLUTION.**

ELIMINODOR<sup>®</sup> is a finely balanced blend of oils and other chemicals specifically developed to neutralise cooking odours.

The contamination of ELIMINODOR<sup>®</sup> with any other ingredients will cause its blend to become unstable and could render ELIMINODOR<sup>®</sup> completely ineffective, it will also nullify all and any manufacturer's warranty supplied by Purified Air Limited for the ELIMINODOR<sup>®</sup> and the O.N.100 unit that it is used in.

## 6.2 Cleaning

### 6.2.1 After Topping up with ELIMINODOR<sup>®</sup>.

Wipe away any spills of ELIMINODOR<sup>®</sup> and associated deposits from the filler spout and the outside surface of the tank (see *Figure 14 - Tank Filler* on page 16).

## 7. Troubleshooting



### WARNING!

If the Unit does not function (correctly), consult the checklist below to see if it is possible to remedy the error yourself. Should this not be possible, consult a qualified service engineer.



### INFORMATION

A number of problems in the checklist below can also be caused by defects in the connected equipment. This manual only deals with problems and solutions directly related to the Unit itself.

### 7.2.1 Troubleshooting Checklist

Problem	Possible Cause	Solution
Cooking odours strongly detectable at the extract duct's outlet	Unit has run out of ELIMINODOR® solution.	Re-fill tank with ELIMINODOR® solution.
	Insufficient ELIMINODOR® solution is being introduced into the extract airstream.	Gradually turn the Control Damper's knob clockwise to increase the airflow passing through the Unit and the quantity of ELIMINODOR® solution evaporated. In conjunction with gradually adjusting the Liquid Control Rate knob up.
A strong smell of ELIMINODOR® solution is still present when the kitchen is busy.	Excess ELIMINODOR® solution is being introduced into the extract airstream.	Gradually turn the Control Damper's knob anti-clockwise to decrease the airflow passing through the Unit and the quantity of ELIMINODOR® solution evaporated. In conjunction with gradually adjusting the Liquid Control Rate knob down.
More than a trace of ELIMINODOR® solution can be seen in the Spigot or the tube leaving the Unit.	Excess ELIMINODOR® solution is being introduced into the extract airstream.	Gradually turn the Control Damper's knob anti-clockwise to decrease the airflow passing through the Unit and the quantity of ELIMINODOR® solution evaporated. In conjunction with gradually adjusting the Liquid Control Rate knob down.

## 8. Spare Parts List

### 8.1 Spare Parts Ordering

The following items are available to order:

PCB Board

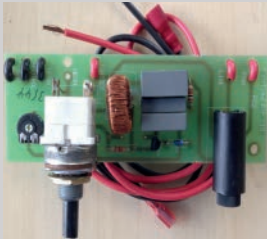

HVPS



Fan



Hose



Damper Assembly



Non Conductive Venturi spigot.

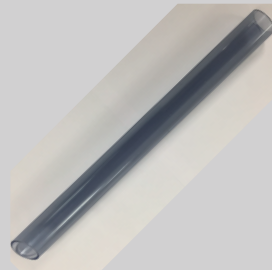

## 9. Unit Wiring Diagram

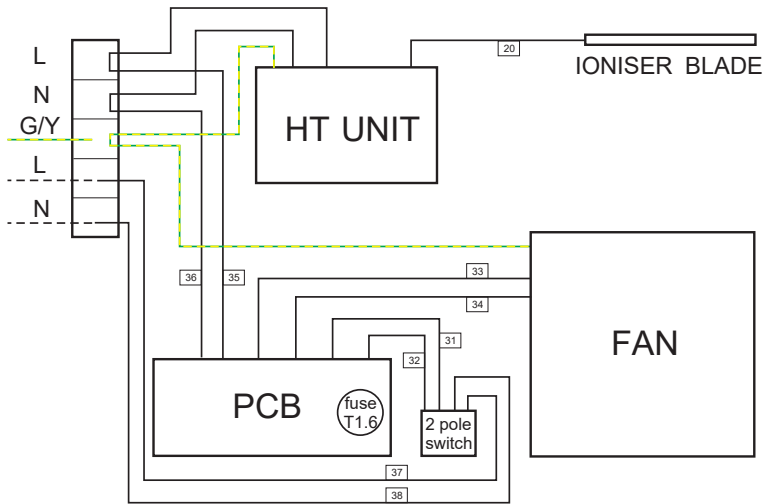

G/Y = Earth

20 12kV to IONISER

31 live to PCB

33 live to FAN

35 live from PCB to HT UNIT

36 neutral from PCB to HTUNIT

32 neutral to PCB

34 neutral to FAN

37 live in

38 neutral in

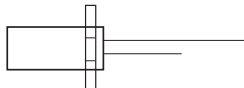

float assembly fitted to the base unit and wired onsite

**Figure 14 - Unit Wiring Diagram**

## 10.

### 10.1 Equipment Disposal

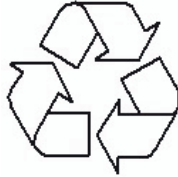

### 10.2 Packaging Material Disposal

The purpose of the packaging is to protect the Unit during transport. It consists of the following substances that can be reused:

Cardboard (corrugated)

Do not dispose of the packaging material in the industrial waste.



#### **INFORMATION**

The Unit's Packaging materials are manufactured from recyclable materials in accordance with applicable local regulations.

### 10.3 Used Unit Disposal

Units which you would like to dispose of may still contain valuable substances and materials.

Do not dispose of the Unit as general industrial waste.

---

## 11. Contact Details

At Purified Air, we pride ourselves on our excellent levels of customer service and maintenance.

### 11.1 Nationwide Coverage

We have hubs in both Manchester and London and can offer nationwide coverage with teams of directly employed service engineers.

For all Service and Maintenance enquiries, please contact via:

[service@purifiedair.com](mailto:service@purifiedair.com)

**0800 018 4000**

### 11.2 Service and Maintenance Contracts

With every installation, we offer the opportunity to sign up for one of our service and maintenance contracts, these are structured to suit individual needs, on a post pay basis with the customer only being invoiced after each service, saving them both time and money against ad hoc servicing requests.

### 11.3 Dependability

So whether you have our commercial kitchen exhaust filtration equipment in your restaurant, cafe or take away, you can rest assured that we will always be there when you need us.

### 11.4 Global Sales

For all installations of our equipment outside of the UK, please refer back to your designated distributor.

## 12. Warranty Statement

Your new O.N.100 Odour Neutraliser is guaranteed against the cost of breakdown repairs for one year from the date of the original purchase.

The manufacturer does not accept any liability for damage to the Unit or personal injury caused by non-observance of the safety instructions in this manual or negligence during the installation, use, maintenance and repair of the models mentioned on the cover of this manual and any associated accessories.

### What is covered?

- Repairs necessary as a result of faulty materials, defective components or manufacturing defect.
- The cost of functional replacement parts, but excluding consumable items.

### What is not covered?

- Transit, delivery or accidental damage or misuse and abuse.
- Any installation which fails to meet the installation, location and operating requirements and parameters outlined in this manual.
- Manufacturing defects only affecting the Unit's cosmetic appearance.
- Consumable items including but not limited to ELIMINODOR<sup>®</sup> neutralising solution.
- Repairs required as a result of unauthorised repair or installation by anyone other than a Purified Air approved installer.
- Any damage caused to the Unit by its use by anyone other than authorised, trained and qualified users or personnel under the supervision and responsibility of authorised, trained and qualified users.
- Any damage caused to the Unit by incorrect servicing procedures.
- Use of the Unit in any application which is not specifically mentioned in this manual or approved, in writing, by the manufacturer.
- The guarantee is applicable only to new products and is not transferable if the product is resold.

Purified Air disclaims any liability for incidental or consequential damages.

The guarantee does not in anyway diminish your statutory or legal rights.

Please keep your purchase receipt or other proof of purchase in a safe place. you will need to have it should the product require attention under guarantee.



## 13. Certification

### 13.1 EC Declaration of Conformity

Purified Air Limited  
Lyon House  
Lyon Road  
Romford  
Essex RM12BG

Tel: +44 1708 755414  
Fax: +44 1708 721488  
Email: [enq@purifiedair.co.uk](mailto:enq@purifiedair.co.uk)  
[www.purifiedair.co.uk](http://www.purifiedair.co.uk)

**purified**  **air**



### EC Declaration of Conformity

Document Number: DoC ON100 1201

We, Purified Air Limited at above address, declare the products detailed below comply with the requirements of the following EU Directives,

- Low Voltage Directive 2014/35/EU
- Electromagnetic Compatibility Directive 2014/30/EU
- RoHS Directive 2011/65/EU

Equipment description	Odour <i>control</i> unit
Make/Brand	Purified Air
Model reference	ON100

Compliance of the equipment has been assessed with respect to the essential requirements and with reference to the following harmonised standard:

- EN 60204-1:2006 +A1:2009

A technical file for this equipment is retained at the above address

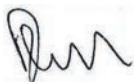

David Collins  
Managing Director.  
Purified Air Limited  
January 2017

## 14. Safety Datasheets

### 14.1 ELIMINODOR<sup>®</sup> Health and Safety Datasheet

#### 1. IDENTIFICATION OF SUBSTANCE / PREPARATION AND COMPANY

COMPOUND NAME:	O.N.100 DEODORIZING LIQUID
CODE NUMBER:	83750
COMPANY:	Purified Air Limited, Lyon House, Lyon Road, Romford, Essex. RM1 2BG England
TELEPHONE NUMBER:	01708 755414

#### 2. COMPOSITION AND INFORMATION ON INGREDIENTS

This is a concentrated fragrance compound, containing a mixture of aroma chemicals and natural essential oils.

#### 3. HAZARDS IDENTIFICATION

GENERAL:	When undiluted and not properly handled this may cause irritation to skin and eyes or by inhalation.
HAZARD SYMBOL:	See COSHH sheet 14.1
RISK CODES:	None required.
ENVIRONMENT:	Keep away from drains, surface and ground water, and soil to avoid possible contamination.

#### 4. FIRST AID MEASURES

INHALATION:	Remove from the exposure area to fresh air. Contact a doctor if necessary. If breathing has stopped start resuscitation.
INGESTION:	Obtain medical advice immediately.
SKIN CONTACT:	Remove contaminated clothing. Wash with plenty of soap and water.
EYE CONTACT:	Flush with plenty of water and seek medical advice if necessary.

#### 5. FIRE-FIGHTING MEASURES

EXTINGUISHING MEDIA:	Carbon dioxide, foam or dry powder – DO NOT USE A DIRECT WATER JET.
COMBUSTION UNITS:	Carbon dioxide and unidentified organic compounds.
SPECIAL PROTECTIVE EQUIPMENT FOR FIRE FIGHTERS ONLY:	Wear protective clothing and avoid inhalation of vapours.

## 6. ACCIDENTAL RELEASE MEASURES

Remove all sources of ignition. Ensure proper ventilation. Avoid inhalation, skin and eye contact. Soak up spillage with sand or other inert absorbent material such as earth or vermiculite.

Transfer used material to a suitable waste container, and dispose in accordance with local regulations. Any absorbent cloth used for mopping up should be treated as oily waste and disposed of promptly.

## 7. HANDLING AND STORAGE

**HANDLING PROCEDURES:** Maintain good occupational and personal hygiene  
Avoid inhalation and contact with skin and eyes.

**STORAGE CONDITIONS:** Store in tightly sealed containers, of amber glass, aluminium or lacquered steel away from ignition sources and in a cool place, preferably 10-20 degC with good ventilation.

## 8. EXPOSURE CONTROLS AND PERSONAL PROTECTION

**EXPOSURE CONTROLS:** Maintain adequate ventilation.

**PERSONAL PROTECTION:** Respiratory Protection - Not generally required.  
Hand Protection - Wear chemically resistant disposable gloves.

Eye Protection - Not normally required. Where there is a risk of splashing wear safety glasses.

Skin Protection - Wear overalls. Always wash routinely before breaks, meals and at the end of the work period.

## 9. PHYSICAL AND CHEMICAL PROPERTIES

Appearance:	LIQUID
Odour:	According to standard
Colour:	YELLOW
PH:	Not determined
Viscosity:	Mobile liquid
Freezing Point degC:	Not determined
Melting Point degC:	Not determined
Flash Point degC:	65
Auto Flammability:	Not determined
Explosive Properties:	Not expected
Oxidising Properties:	Not expected
Vapour Pressure:	Not determined
Relative Density @ 25 degC:	0.8020
Solubility in water:	INSOLUBLE
Partial Coefficient: (n-octanol / water):	Not determined
Refractive Index @ 20 degC:	1.4443

**10. STABILITY AND REACTIVITY**

CONDITIONS TO AVOID: Extreme temperatures and conditions as this may spoil the Unit.

HAZARDOUS DECOMPOSITION UNITS:  
Not determined

**TOXICOLOGY INFORMATION.**

This Unit is a mixture and has not been tested as a whole. No further data is available.

**11. ECOLOGICAL INFORMATION**

None available.

**12. DISPOSAL CONSIDERATIONS**

Dispose in accordance with the law and local regulations.

**13. TRANSPORT INFORMATION**

Class	Packing	Group
-------	---------	-------

UN No:

ADR/RID (Road):

IMDG (Sea):

IATA (Air):

**14. REGULATORY INFORMATION**

HAZARD SYMBOLS: This Product carries a harmful rating

RISK CODES: None required

SAFETY PHRASES:

CONTAINS:



**15. OTHER INFORMATION**

The information in this HSDS is correct to the best of our knowledge. However the accuracy of this information cannot be guaranteed by the company as the data has been obtained from different sources. We will therefore not accept liability for misuse of this data resulting in damage or loss.

## 14.2 COSHH Assessment for ELIMINODOR<sup>®</sup>

### COSHH ASSESSMENT FORM

Substance	Eliminodor
Substance Description	Concentrate fragrance material - Liquid
Is there a safer alternate substance/material?	No
Supplier / Manufacturer	Purified Air Limited
Nature of Use	Concentrated fragrance material for manufacturing purposes.
Storage	Store in well filled and tightly closed original containers, at around +15C and protected from light. Avoid plastic and uncoated metal containers. Store in a cool well ventilated area. Keep away from sources of ignition and naked flames.
Handling Precautions	Apply good manufacturing and industrial hygiene practices and adequate ventilation. Respect good personal hygiene. Smoking, eating and drinking should be prohibited
Use / Application of Substance Used	Concentrate fragrance material.

Hazard Identification (Delete as Appropriate)					
					
Environmental	Harmful/Irritant				

Exposure (Delete as Appropriate)		Engineering Controls	Yes	No
Degree	Low	Can the process be isolated		✓
Duration (hours)	<4	Can the process be controlled	✓	
Quantities	Low	Can ventilation / extraction be used		✓

Hazard Identification	Yes	Level	No		Yes	No
Is there a Workplace Exposure Limit (WEL)?			✓	Hazardous by inhalation?		✓
				Hazardous by ingestion?	✓	
				Hazardous by absorption?	✓	
Irritant to eyes?	✓			Irritant to the skin?	✓	



## COSHH Assessment

If any of the following answers are Yes, attach the relevant data to this assessment	Yes	No
1 Is manufacturer's hazard information sheet available?	✓	
2 Will employees be given the information concerning the hazard?	✓	
3 Will employees be given specific training?	✓	
4 Will exposure monitoring and or control measures be required?	✓	
5 Does the substance need to be disposed of by an authorised waste disposal	✓	
6 Have storage requirements for the substance been provided?	✓	

State any First Aid Measures

Inhalation: No damage to health is expected.

Eye Contact: Remove contact lenses. Irrigate copiously with clean water for at least 10 minutes holding lids apart. Seek medical advice if symptoms persist.

Skin Contact: Remove contaminated clothing. Wash skin thoroughly with soap and water or skin cleaner. Contact physician if irritation persists.

Ingestion: If accidentally swallowed rinse mouth with water. In severe cases seek medical attention and show the safety data sheet.

State any measures to be taken in the event of accidental release: Avoid inhalation and contact with skin and eyes. Use Personal Protective Equipment. Inform fire brigade if there are any large spillages. Keep away from drains, surface and ground water, and soil. Spillages should be contained immediately by use of sand or inert powder and disposed of according to local regulations.

Handling precautions in place: Yes

Maintenance of controls: Supervision of staff and safety inspections



Monitoring of exposure: N/A

Information to staff: First aid arrangements and COSHH details

Written instructions issued: Hazard data sheet and COSHH assessment

Training required: Safe system of work

Health Surveillance: N/A
<p>Fire Precautions:</p> <ul style="list-style-type: none"> <li>• Carbon Dioxide, Foam or Powder Fire Extinguishers to be used.</li> <li>• DO NOT USE WATER EXTINGUISHERS.</li> <li>• Avoid inhalation of fumes during combustion of product – use protection for the respiratory tract.</li> <li>• Contaminated fire extinguishing water must be collected separately; it must not enter sewerage system.</li> </ul>
Storage: Store in a cool, dry and well ventilated area away from sources of heat, ignition and direct sunlight. Avoid plastic and uncoated metal containers.
Transport: Always transport in closed containers that are upright and secure. Ensure that persons transporting the product know what to do in the event of an accident or spillage.
Disposal: Wastes, including emptied containers, are controlled wastes and should be disposed of in accordance with the regulations made under The Control of Pollution Act and the Environment Protection Act. Avoid disposing into drainage systems and into the environment.
Ecological Information: Avoid contaminating the earth as well as surface and ground water.

Personal Protective Equipment					
 <p><b>SAFETY GOGGLES MUST BE WORN</b></p>	 <p><b>HAND PROTECTION MUST BE WORN</b></p>	 <p><b>PROTECTIVE CLOTHING MUST BE WORN</b></p>			
Safety glasses should be worn.	Use chemically resistant gloves.	Use suitable protection clothing.			



**FreePhone (UK Only) 0800 018 4000**  
**International +44 1708 755414**

**Purified Air Limited.** Lyon House, Lyon Road, Romford, Essex. RM1 2BG

[www.purifiedair.com](http://www.purifiedair.com) | [enq@purifiedair.com](mailto:enq@purifiedair.com)